

Stutplanken

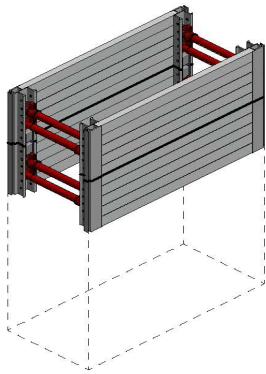

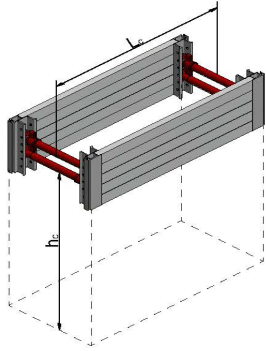

Sleufbekisting

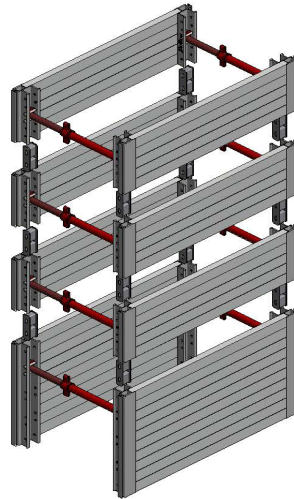
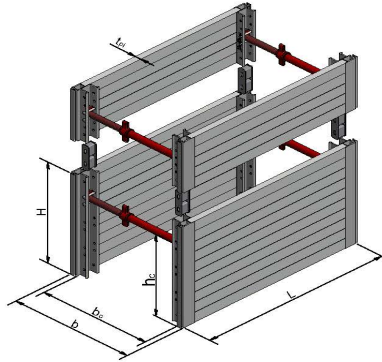

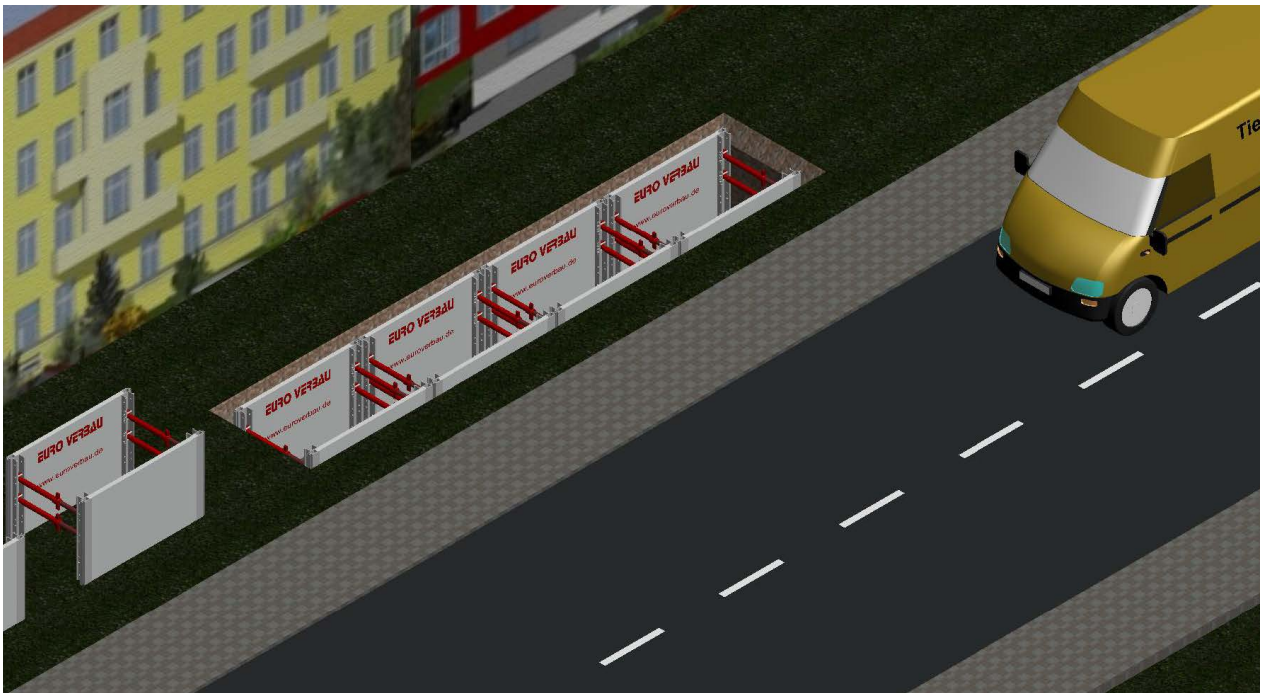
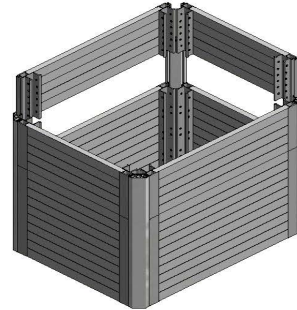
Putten



-  : 3,00 m
-  : 0,71 m
-  : 1,00 m bis 3,00 m

	Afmetingen [mm]	Gewicht Plaat [kg]	Gewicht Element [kg]	Buisdoorlaathoogte h_c [mm]	Buisinleglengte L_c [mm]	Diagonaal max. [mm]	Oppervlak Element [m ²]	Maximale Gronddruk ($R_{k,c}$) [kN/m ²]	Doorbuiging (F) [mm]
Grondplaat	L x H x t_p	met 4 MB Spindels Type A							
ALU 60	3000x1200x60	140	332	565	2730	3317	7,2	33,5	94,2
ALU 60	2500x1200x60	100	252	565	2230	2873	6,0	37,4	76,6
ALU 60	2000x1200x60	86	224	565	1730	2449	4,8	53,3	63,6
ALU 60	1500x1200x60	72	196	565	1230	2061	3,6	69,8	55,8
ALU 60	1000x1200x60	58	168	565	730	1734	2,4	-	-
ALU 60	3000x600x60	70	192	180	2730	3150	3,6	33,5	94,2
ALU 60	2500x600x60	50	152	180	2230	2678	3,0	37,4	76,6
ALU 60	2000x600x60	43	138	180	1730	2218	2,4	52,3	63,6
ALU 60	1500x600x60	36	124	180	1230	1780	1,8	69,8	55,8
ALU 60	1000x600x60	29	110	180	730	1388	1,2	-	-

Hoekgeleidebalk		Plaatlengte [mm]	Uitw. breedte b [mm]	Inw. breedte b _c [mm]
Lengte [mm]	Gewicht [kg]			
3000	34	1500	1800	1660
2400	27	2000	2300	2160
1800	21	2500	2800	2660
1200	14	3000	3300	3160

Mini-Box Spindel	Uitw. breedte b [mm]		Inw. breedte b _c [mm]	
	min.	max.	min.	max.
Spindel Type A	670	748	550	628
Spindel Type B	760	928	640	808
Spindel Type C	946	1293	826	1173
Spindel Type D	1300	2009	1180	1889
Spindel Type E	1990	2720	1870	2600

Artikellijst

Artikel		Afmeting [mm]	Artikel-Nr.	Gewicht [kg]	Stuks
Grondplaat	ALU 60	1000 x 1200	-	58	
	ALU 60	1500 x 1200	-	72	
	ALU 60	2000 x 1200	-	86	
	ALU 60	2500 x 1200	-	100	
	ALU 60	3000 x 1200	-	140	
	ALU 60	1000 x 600	-	29	
	ALU 60	1500 x 600	-	36	
	ALU 60	2000 x 600	-	43	
	ALU 60	2500 x 600	-	50	
	ALU 60	3000 x 600	-	70	
Hoek Geleidebalk		3000	-	34	
		2400	-	27	
		1800	-	21	
		1200	-	14	
MB Spindel	Typ A		1110650	13	
	Typ B		1110740	14,5	
	Typ C		1110920	17	
	Typ D		1111280	21,5	
	Typ E		1111780	41	
Draadstang	für Typ A		1120343	7,0	
	für Typ B		1120433	7,7	
	für Typ C		1120611	9,1	
	für Typ D		1120974	12,1	
	für Typ E			12,3	
Huls	für Typ A		1120288	4,9	
	für Typ B		1120378	5,5	
	für Typ C		1120564	6,3	
	für Typ D		1120918	8,0	
	für Typ E			27,3	
Kunststof nok		85 x 135 mm		0,2	
Bout		Ø20 x 140 mm	1700140	0,4	
Veersteker		92	1700092	0,1	
Koppelstuk			-	3,3	
Strop, 4-sprong		1800 x 20	170423s	39,0	

Een grondelement bevat: 4 St. Spindels

Voor de koppeling tussen 2 elementen heeft men nodig: 4 St. Koppelstukken
8 St. Bouten Ø20 mm
4 St. Veerstekers

Een minibox spindel bestaat uit: 1 St. Spindel
4 St. Bouten Ø20 mm
4 St. Veerstekers